



jarik[™]
fluid cushion

www.jarikmedical.com



	3
	4
	6
	8
	8
	9
	10



JARIK FLUID WHEELCHAIR CUSHION

PRESSURE SORE PREVENTION AND BETTER POSTURE

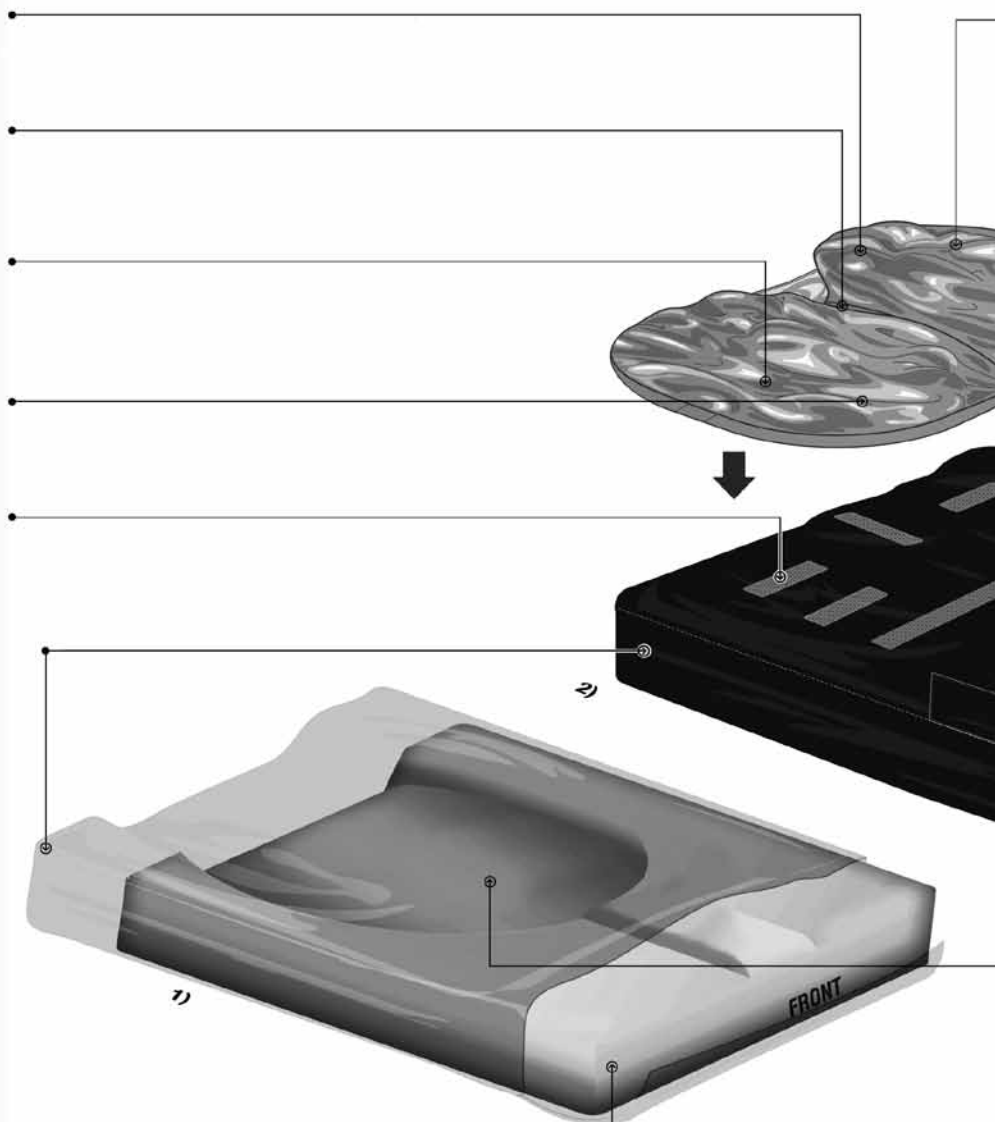

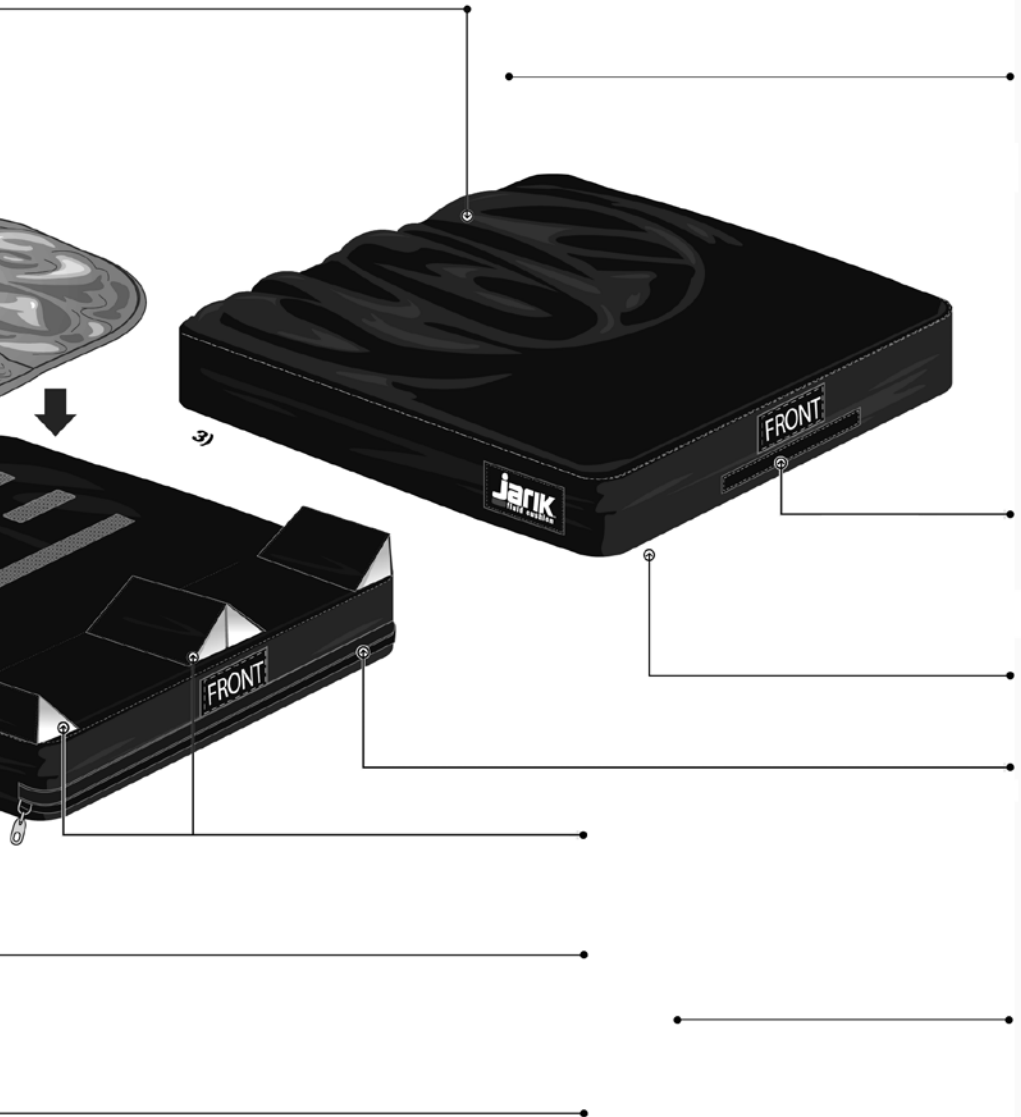

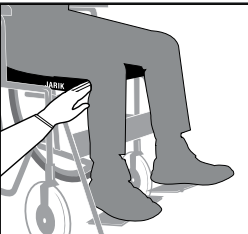
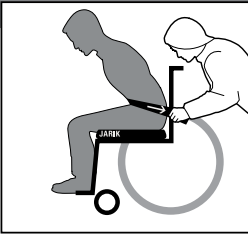
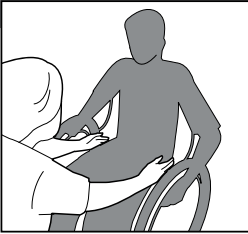

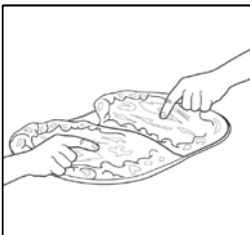
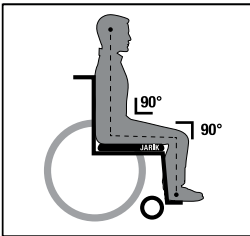
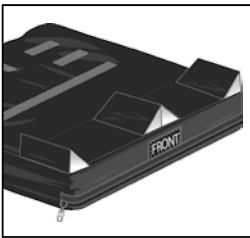
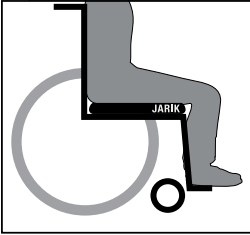



To do this:

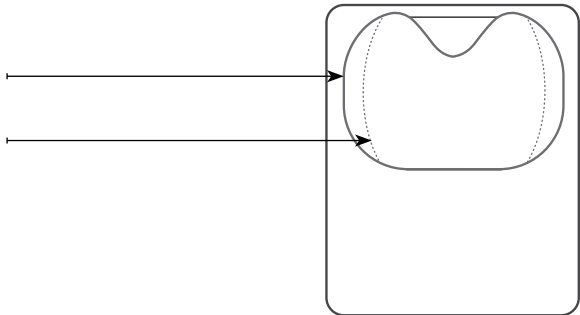
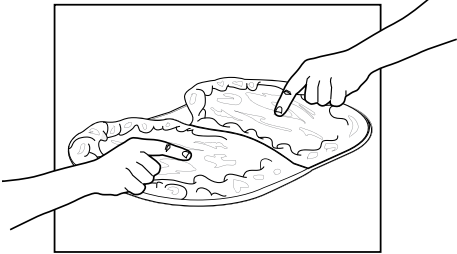

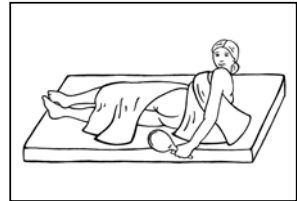
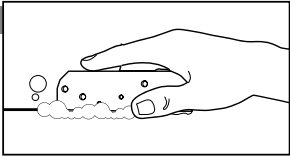

Courtesy www.motivation.org

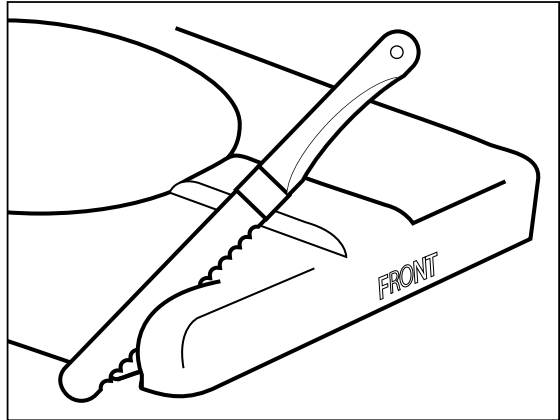

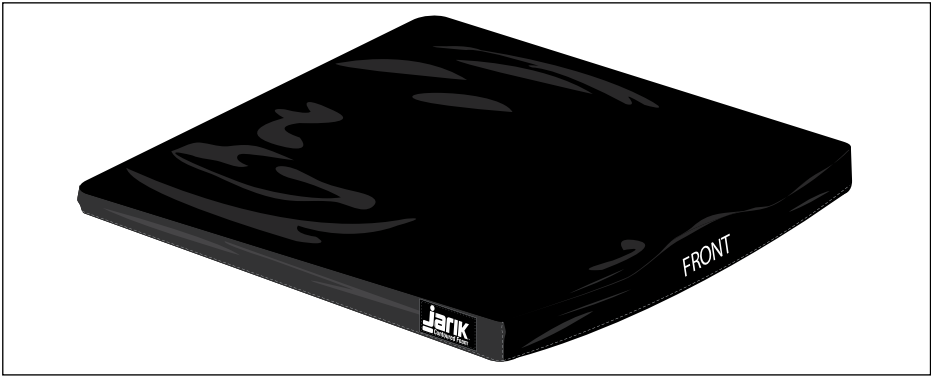

CONTACT US AT OUR WEBSITE AT:

www.jarikmedical.com

JARIK medical

855 Circle Drive
Boulder, CO 80302
U.S.A.

info@jarikmedical.com



www.jarikmedical.com



JARIK Medical
855 Circle Drive
Boulder, CO 80302
U.S.A.
info@jarikmedical.com